



Instruction Manual

20V Cordless Grass Trimmer

PLU-156436



Before any use, refer to the corresponding paragraph in the present manual.

Safety instructions

---General safety instructions



WARNING! Read all safety warnings and all instructions.

Failure to follow the warnings and instructions may result in electric shock, fire and/or serious injury.

Save all warnings and instructions for future reference.

The term "power tool" in the warnings refers to your corded power tool or battery pack-operated power tool.

- This product is not intended for use by persons (including children) with reduced physical, sensory or mental capabilities, or lack of experience and knowledge, unless they have been given supervision or instruction concerning use of the appliance by a person responsible for their safety.
- Only use the product in the manner and for the functions described in these instructions.

Work area safety

- Keep work area clean and well lit. Cluttered or dark areas invite accidents
- Do not operate power tools in explosive atmospheres, such as in the presence of flammable liquids, gases or dust. Power tools create sparks which may ignite the dust or fumes.
- Keep children and bystanders away while operating a power tool. Distractions can cause you to lose control.

Electrical safety

- Power tool plugs must match the outlet. Never modify the plug in any way. Do not use any adapter plugs with grounded power tools. Unmodified plugs and matching outlets will reduce risk of electric shock.
- Do not expose power tools to rain or wet conditions. Water entering a power tool will increase the risk of electric shock.
- Do not abuse the cord. Never use the cord for carrying, pulling or unplugging the power tool. Keep cord away from heat, oil, sharp edges or moving parts. Damaged or entangled cords increase the risk of electric shock.
- When operating a power tool outdoors, use an extension cord suitable for outdoor use. Use of a cord suitable for outdoor use reduces the risk of electric shock.
- If the supply cord is damaged, it must be replaced by the manufacturer, its service agent or similarly qualified persons in order to avoid a hazard.
- It is recommended that appliances should be supplied via a residual current device (RCD) with a tripping current of not more than 30mA.

Personal safety

- Stay alert, watch what you are doing and use common sense when operating a power tool. Do not use a power tool while you are tired or under the influence of drugs, alcohol or medication. A moment of inattention while operating power tools may result in serious personal injury.
- Use personal protective equipment. Always wear eye protection. Protective equipment such as dust mask, non-skid safety shoes, hard hat, or hearing protection used for appropriate conditions will reduce personal injuries.
- Prevent unintentional starting. Ensure the switch is in the off-position before connecting to power source and/or battery pack, picking up or carrying the tool. Carrying power tools with your finger on the switch or energizing power tools that have the switch on invites accidents.
- Remove any adjusting key or wrench before turning the power tool on. A wrench or a key left attached to a rotating part of the power tool may result in personal injury.
- Do not overreach. Keep proper footing and balance at all times. This enables better control of the power tool in unexpected situations.
- Dress properly. Do not wear loose clothing or jewelry. Keep your hair, clothing and gloves away from moving parts. Loose clothes, jewelry or long hair can be caught in moving parts.

Power tool use and care

- **Do not force the power tool.** Use the correct power tool for your application. The correct power tool will do the job better and safer at the rate for which it was designed.
- **Do not use the power tool if the switch does not turn it on and off.** Any power tool that cannot be controlled with the switch is dangerous and must be repaired
- **Disconnect the plug from the power source and/or the battery pack from the power tool before making any adjustments, changing accessories, or storing power tools.** Such preventive safety measures reduce the risk of starting the power tool accidentally.
- **Store idle power tools out of the reach of children and do not allow persons unfamiliar with the power tool or these instructions to operate the power tool.** Power tools are dangerous in the hands of untrained users.
- Maintain power tools. Check for misalignment or binding of moving parts, breakage of parts and any other condition that may affect the power tool's operation. If damaged, have the power tool repaired before use. Many accidents are caused by poorly maintained power tools.
- **Keep cutting parts sharp and clean.** Properly maintained cutting tools with sharp cutting edges are less likely to bind and are easier to control.
- Use the power tool, accessories and tool bits etc. in accordance with these instructions, taking into account the working conditions and the work to be

performed. Use of the power tool for operations different from those intended could result in a hazardous situation.

CORDLESS GRASS TRIMMER SAFETY WARNINGS

- 1. Keep all parts of the body away from the cutting blade. Do not remove cut material or hold material to be cut when blades are moving. Make sure the product is switched off when clearing jammed material.** A moment of inattention while operating the product may result in serious personal injury.
- 2. Carry the product by the handle with the cutter blade stopped. When transporting or storing the product always fit the cutting device cover.** Proper handling of the product will reduce possible personal injury from the cutter blades.
- 3. Hold the product by insulated gripping surfaces only, because the cutter blade may contact hidden wiring of its own cord.** Cutter blades contacting a “live” wire may make exposed metal parts of the product “live” and could give the operator an electric shock.
4. Check the hedge for foreign objects before operation, e.g. wire fences.
5. Hold the product properly, e.g. with both hands if two handles are provided. Loss of control can cause personal injury.

ADDITIONAL SAFETY WARNINGS

IMPORTANT. Read carefully before use. Keep for future reference

Training

- Read the instructions carefully. Be familiar with the controls and the proper use of the appliance.
- Never allow children to use the product.
- Never allow people unfamiliar with these instructions to use the appliance. Local regulations may restrict the age of the operator.
- Never operate the appliance while people, especially children, or pets are nearby.
- The operator or user is responsible for accidents or hazards occurring to other people or their property.

Preparation

- Wear safety goggles and ear muffs while operating.
- Always wear substantial footwear and long trousers. Do not operate the equipment when barefoot or wearing open sandals.
- Always wear suitable working clothes while operating, which allows freedom of movement.

- Never operate the appliance which is damaged, incomplete or changed without approval of the manufacturer.

Operation

- Disconnect the battery from the product:
whenever you leave the product,
before clearing a blockage,
before checking, cleaning or working on the product,
if the product starts to vibrate abnormally.
- Operate the product only in daylight or in good artificial light.
- Do not overreach and keep your balance at all times.
- Always be sure of your footing on slopes.
- Walk, never run.
- Keep all ventilation openings clear of debris.
- Never blow debris in the direction of bystanders.

Maintenance and storage

- 1) Keep all nuts, bolts and screws tight to be sure the product is in safe working condition.
- 2) Replace worn or damaged parts.
- 3) Store the product only in a dry place.

Residual risks

Even if you are operating this product in accordance with the provisions, residual risks will always still remain. The following dangers can arise in connection with the structure and design of this product:

- 1). Health defects resulting from vibration emission if the product is being used over longer period of time or not adequately managed and properly maintained.
- 2). Injuries and damage to property due to broken accessories or hidden objects that are thrown in the process of using the Grass Trimmer.
- 3). Injuries and damage to property due to thrown and fallen objects.

WARNING! This product produces an electromagnetic field during operation! This field may under some circumstances interfere with active or passive medical implants! To reduce the risk of serious or fatal injury, we recommend persons with medical implants to consult their physician and the medical implant manufacturer before operating this product!

Vibration and noise reduction

To reduce the impact of noise and vibration emission, limit the time of operation, use

low-vibration and low-noise operating modes as well as wear personal protective equipment.

Emergency

Familiarize yourself with the use of this product by means of this instruction manual. Memorize the safety directions and follow them to the letter. This will help to prevent risks and hazards.

- 1). Always be alert when using this product, so that you can recognize and handle risks early. Fast intervention can prevent serious injury and damage to property.
- 2). Stop the motor and disconnect the battery from the product if there is any malfunction. Have the product checked by a qualified professional and repaired, if necessary, before you put it into operation again.

Safety Warnings and Instructions: Batteries

- Do not disassemble or open, drop (mechanical abuse), crush, bend or deform, puncture, or shred.
- Do not modify or remanufacture, attempt to insert foreign objects into the battery, immerse or expose to water or other liquids, or expose to fire, excessive heat including soldering irons, or put in microwave oven.
- Only use the battery/tool with a charging system specified by the manufacturer/supplier.
- Do not short-circuit a battery or allow metallic or conductive objects to contact both battery terminals simultaneously.
- Dispose off used batteries promptly according to the manufacturer/supplier's instructions.
- Improper battery/tool use may result in a fire, explosion, or other hazard.
- Battery/tool usage by children should be supervised.

Safety Warnings and Instructions: Charging

1. This manual contains important safety and operating instructions.
2. Before using battery charger, read all instructions and cautionary warnings on battery charger and product using battery. **CAUTION:** To reduce the risk of injury, use this charger only with this product. Batteries in other products may burst causing personal injury or damage.
3. Do not expose charger to rain or snow.
4. Use of an attachment not recommended may result in a risk of fire, electric shock, or injury to persons.
5. To reduce risk of damage to electric plug and cord, pull by plug rather than cord when disconnecting charger.
6. Make sure cord is located so that it will not be stepped on, tripped over, or otherwise subjected to damage or stress.
7. Use only the supplied charger when charging your tool. The use of any other charger could damage the tool or create a hazardous condition.
8. Use only one charger when charging.
9. Do not attempt to open the charger. There are no customer serviceable parts

inside.

10. DO NOT incinerate the tool or batteries even if they are severely damaged or completely worn out. The batteries can explode in a fire. Toxic fumes and materials are created when lithium ion battery packs are burned.
11. Do not charge or use battery in explosive atmospheres, such as in the presence of flammable liquids, gases or dust. Inserting or removing the battery from the charger may ignite the dust or fumes.
12. If battery contents come into contact with the skin, immediately wash area with mild soap and water. If battery liquid gets into the eye, rinse water over the open eye for three minutes or until irritation ceases. If medical attention is needed, the battery electrolyte is composed of a mixture of liquid organic carbonates and lithium salts.







WARNING: Burn hazard. Battery liquid may be flammable if exposed to spark or flame.

PRODUCT SPECIFICATIONS

Rated Voltage	20V DC
No Load Speed	8500rpm
Cutting Device	Trim fast blade
Cutting Swath Diameter	240mm
Weight (with battery pack)	1.5kg
Guaranteed sound power level	90dB(A)
Battery Pack	Lithium Ion – 2000mA

These instructions should be read in conjunction with the instruction manual for the battery pack and charger.

SYMBOLS

	<p>Warning, safety alert.</p>
	<p>Read and follow all safety precautions in the owner's manual.</p>
	<p>Protective goggles/visor, protective helmet & hearing protection.</p>
	<p>Do not expose to rain.</p>
	<p>Beware of thrown or flying objects to bystanders. Keep bystanders a safe distance away from the machine.</p>
	<p>Thrown objects can ricochet and result in personal injury or property damage. Wear protective clothing and boots.</p>
	<p>Beware of falling objects. Keep bystanders away.</p>

CHARGING PROCEDURE

IMPORTANT: The battery pack is not fully charged at the factory. Before attempting to charge them, thoroughly read all of the safety instructions.

- (1) To assure that the charger you use are applicable to the battery pack.
- (2) Plug the charger plug into the charging hole of the battery pack.
- (3) Plug the charger into any suitable standard outlet.

(4) Let the battery pack charge initially for the green light is twinkled. If the power lights are all lighting, the battery pack is fully charged.

Recharge discharged batteries as soon as possible after use or battery life may be greatly diminished. For longest battery life, do not discharge batteries fully.

It is recommended that the batteries be recharged after each use.

WARNING: Fire Hazard. When unplug the output plug from the charging hole, be sure to unplug the charger from the outlet first, then disconnect the charger output plug from the charging hole.

Important Charging Notes

1. Your tool was sent from the factory in an uncharged condition. Before attempting to use it, it must be charged.
2. **CAUTION:** To reduce the risk of damage to the batteries, NEVER charge them in an air temperature below 40°F (4.5°C) or above 105°F (40.5°C). Also, NEVER charge them if the battery temperature is below 40°F (4.5°C) or above 105°F (40.5°C). Longest life and best performance occurs when batteries are charged with an air temperature of approximately 75°F (24°C). **NOTE:** The tool will not charge if the tool temperature is below approximately 32°F (0°C) or above 113°F (45°C).
3. While charging, the charger may hum and become warm to touch. This is a normal phenomenon and does not indicate a problem.
4. If the batteries do not charge properly—(1) Check current at receptacle by plugging in a lamp or other appliance. (2) Check to see if receptacle is connected to a light switch which turns power off when you turn out the lights. (3) Move charger and tool to a surrounding air temperature of 40°F (4.5°C) to 105°F (+40.5°C). (4) If the receptacle and temperature are OK, and you do not get proper charging, take or send the tool and charger to your local service center. See Tools Electric in yellow pages.
5. The tool should be recharged when it fails to produce sufficient power on jobs which were easily done previously. Battery life may be greatly diminished if batteries are discharged deeply. **DO NOT CONTINUE** using product with its batteries in a depleted condition. Recharge discharged batteries promptly.
6. To maximize battery life:
 - a. Do not fully discharge batteries.
 - b. Fully recharge batteries after each use.
 - c. Store tool in a location where the surrounding air temperature is approximately 40°F-75°F (4.5°C - 24°C).
 - d. Disconnect charger from tool after charge is complete. **WARNING:** Fire Hazard. When disconnecting the charger from the tool, be sure to unplug the charger from the outlet first, then disconnect the charger cord from the tool.

ASSEMBLY



Warning! Remove the battery pack before cleaning or maintaining the tool, fitting the plant guard before making any adjustments to the tool, especially around the string head. Remove battery pack before transporting or storing the tool.

Attaching or Replacing Blade

Place the wider eyelet of cutting blade over the metal stud and firmly pull until blade is completely seated on stud.

Remove in opposite order

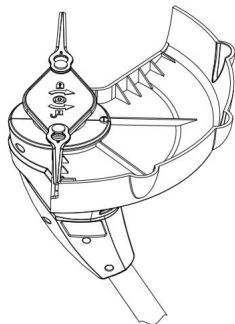

Fig.1

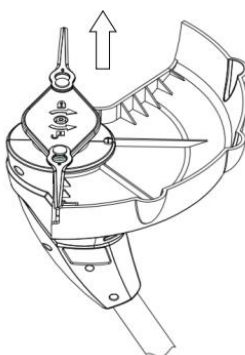

Fig.2

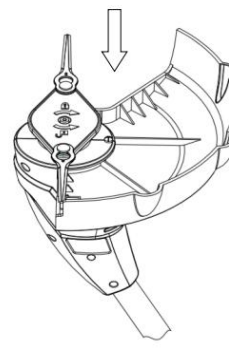

Fig.3

Fitting the guard and connecting the tube

The guard is an essential part of the tool and must ALWAYS be used. Otherwise damage to the trimmer and injury to the operator may occur. The guard is not fitted to the trimmer when it is delivered to you to avoid damage in transit.

Align the guard with the trimmer head as shown (Fig.4), Before install the guard to the machine you need to check the two hole(item1 and item 2) is accordance, then use screw (item 3) to connect tight with the hole.

Insert the tube then tight then as shown(Fig.5).

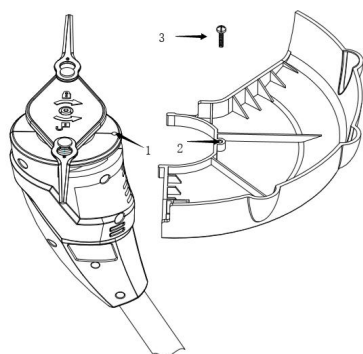

Fig.4

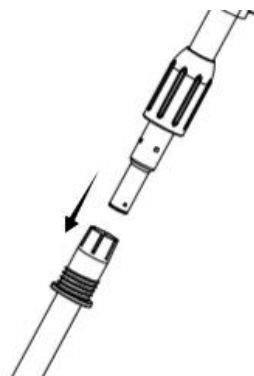

Fig.5

Fitting and Removing the battery



The battery should always be removed whenever you are not using the tool and especially when you are adjusting or transporting the tool to avoid accidental operation.

To insert the battery, slide it into the grass trimmer until it latches into place. Check that the battery is securely locked into place (Fig.6)



Fig.6

To remove the battery, press and hold the button on the two side of the battery pack and slide the battery away from the trimmer.

OPERATION



BEFORE OPERATING THIS TOOL, ENSURE THAT THE GUARD IS FITTED TO THE HEAD OF THE MACHINE. NEVER USE THE MACHINE WITHOUT THE GUARD

Starting/Stopping the trimmer:

To switch the trimmer on, first press the unlock knob(item 2) then hold the switch handle(item 1), the trimmer is now running. You can release the unlock knob.

To switch the trimmer off, release the switch handle. Be aware that the blade will continue to rotate for a short period.

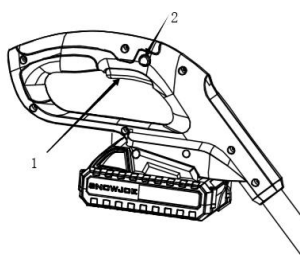

Fig.7

Adjusting Auxiliary handle (Fig.8)

The auxiliary handle (item 1) is height and angle adjustable. To adjust the handle,

first release the handle lock nut on the side of the handle. Rotate the auxiliary handle to desired position and slide the handle support to the desired height, clamp lock nut (item 2) in position. Tighten the lock nut.

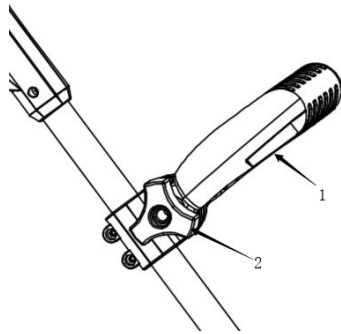

Fig.8

Maintenance, storage and disposal

1. Disconnect the battery pack from the machine before carrying out maintenance or cleaning work.
2. When not in use store the machine out of the reach of children.
3. To clean the tool, remove battery pack and use only mild soap and a damp cloth to clean the tool. Do not immerse tool in water or spray with a hose. Do not allow any liquid to get inside it. Do not clean with a pressure washer.
4. Inspect and maintain the machine regularly. Have the machine repaired only by an authorized repairer.
5. The battery must be removed from the appliance before it is scrapped.
6. The appliance must be disconnected from the supply mains when removing the battery.
7. The battery is to be disposed off safely.